

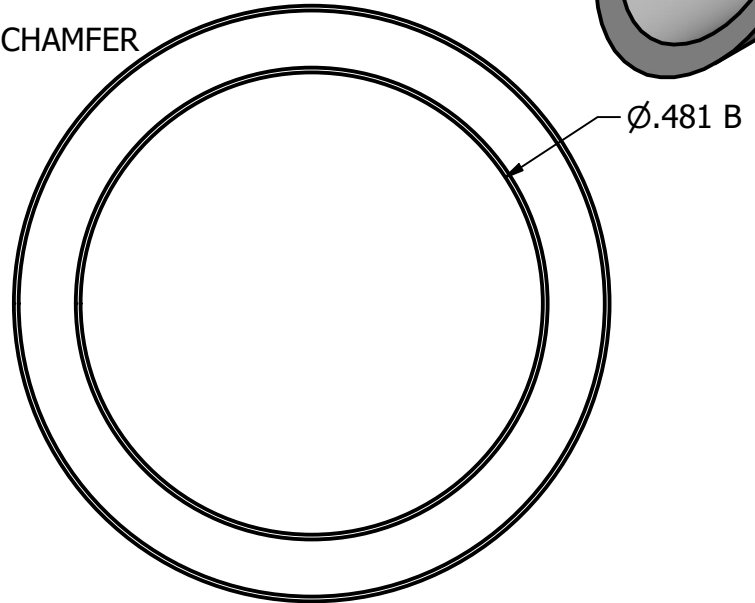

REVISION HISTORY

ZONE	REV	DESCRIPTION	DATE	APPROVED
	0		12/1/2019	

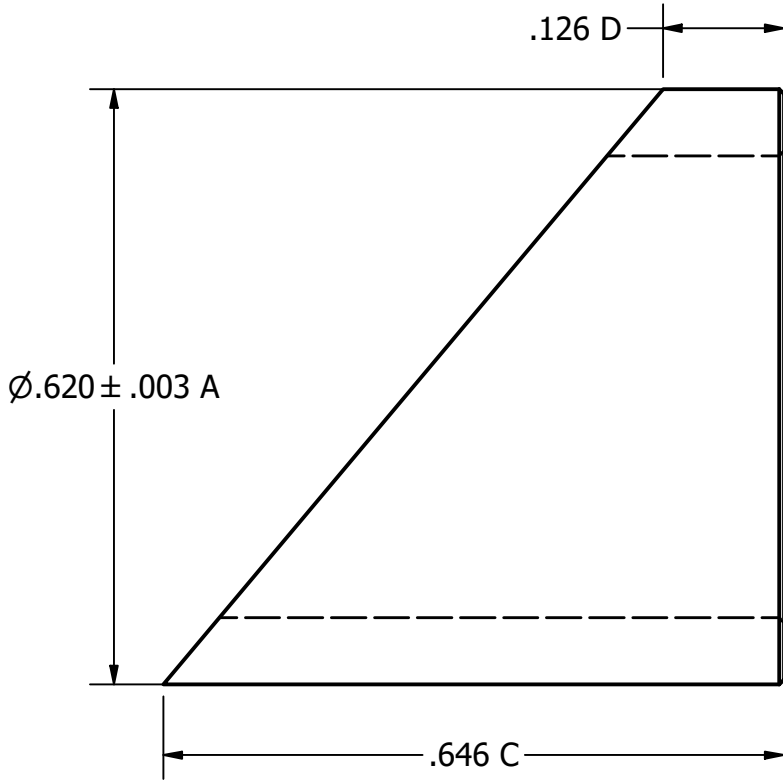

CRITICAL TOLERANCES		
DIMENTION	TOLERANCE	DEVICE
A	+/- .003	CALIPER
B	+/- .003	CALIPER
C	+/- .003	CALIPER
D	+/- .003	CALIPER

		PART #: 254828 Cable Angle Washer 40 Degree		PART NAME: 254828 Cable Angle Washer 40 Degree.ipt			
DRAWN BY: RWM		DATE: 8/27/2020		STATUS: WorkInProgress			
TOLERANCES .X = ± .030 .XX = ± .015 .XXX = ± .005				CYCLE TIME:		MATERIAL:	
SIZE: A		SCALE: 2				REV:	